

SOLUTION

ABKANTTECHNOLOGIE

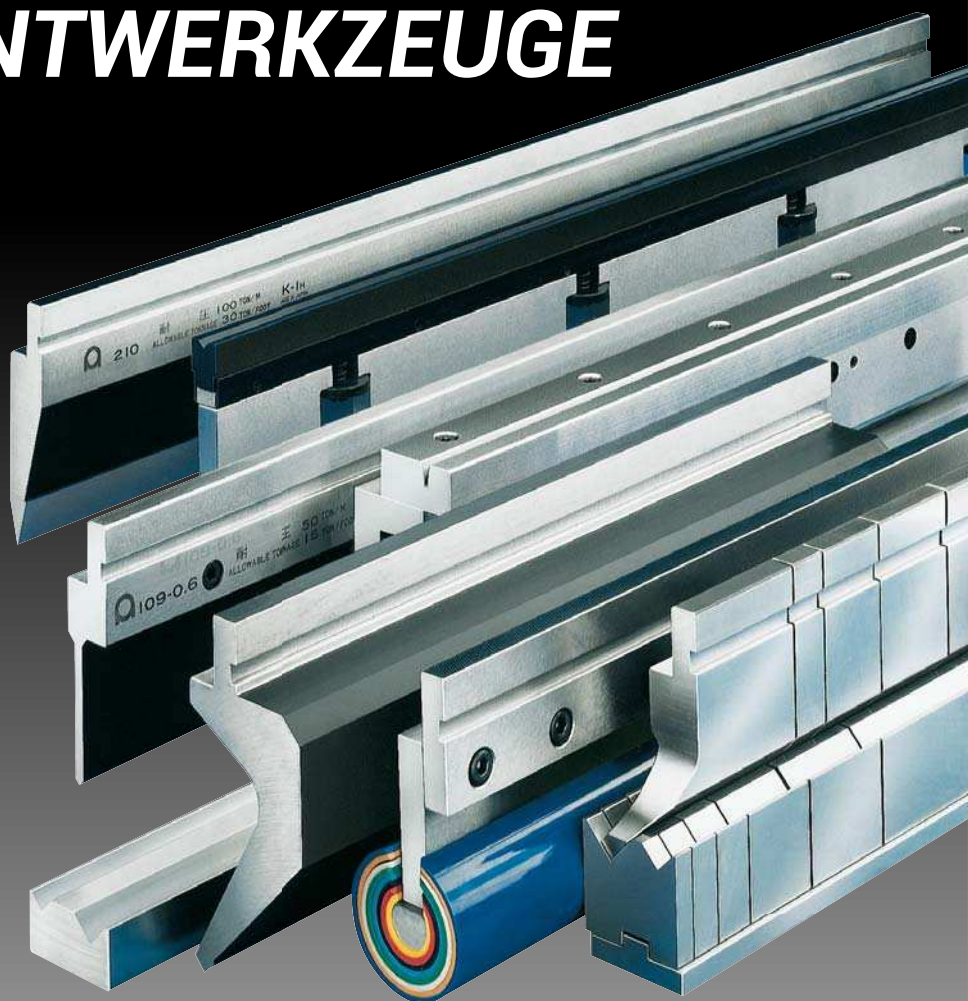

ABKANTWERKZEUGE



AMTS

 **AMADA**[®]

Inhaltsverzeichnis

Inhaltsverzeichnis	2
bending_tools	3
Stempel	3
30° Stempel	3
88° Stempel	6
90° Stempel	14
Matrize	22
1-V / 30°	22
1-V / 88°	23
1-V / 90°	29
Presskrafttabelle fürs Freibiegen	35
Normalstahl	35
Edelstahl	36

Matrizen Qualität: AMANIT®

AMANIT® Werkzeuge bieten die optimalsten Eigenschaften für Anwendungen, wo gleichzeitig sehr hoher Verschleiß und extreme Belastung zusammenkommen.

- höchste Verschleißfestigkeit (HRC 60-65)
- weniger Reibung
- Kernfestigkeit - 1150 N/mm²
- Rostschutz

Somit sind diese Werkzeuge den Laser- oder induktionsgehärteten Werkzeugen weit überlegen

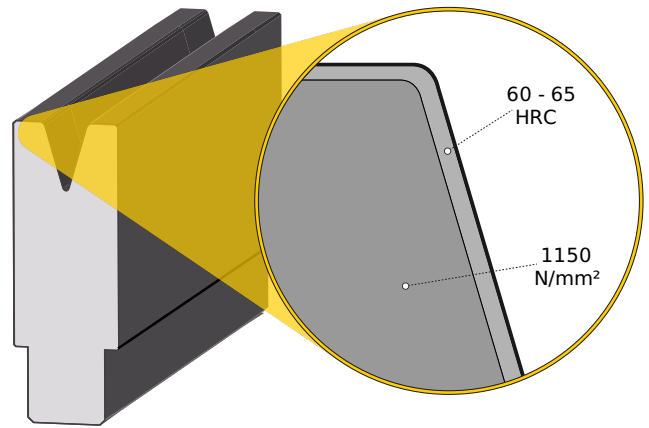

Werkzeugtyp Winkel Max. Belastbarkeit Produktionsdatum



00406 88° ALLOWABLE TONNAGE
R0.6 (.024) MAX: 1000kN/m {100 ton/m}
(32.874) MAX: 30 TON/FOOT

A-8A
MADE IN AUSTRIA

Länge mm (inch) Spitzenradius / Schulterradius mm (inch) Ursprungsland

Verfügbare Stempel Längen

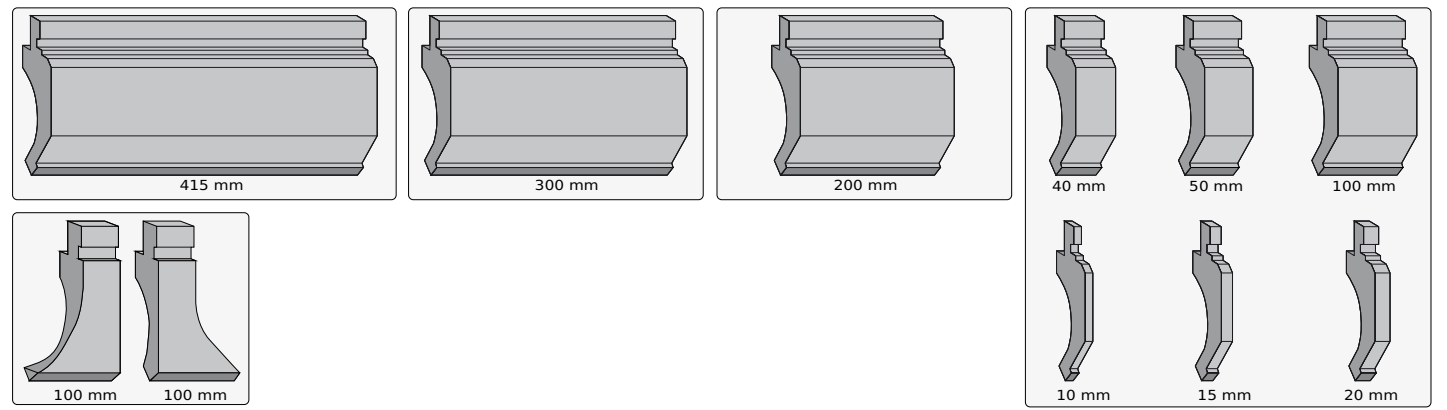
Lang	Kurz	Sektioniert	Extra Kurz	Horn
415 mm	300 mm	235 mm	200 mm	100 mm



Verfügbare Matrizen Längen

Lang	Kurz	Sektioniert	Extra Kurz
415 mm	300 mm	235 mm	200 mm

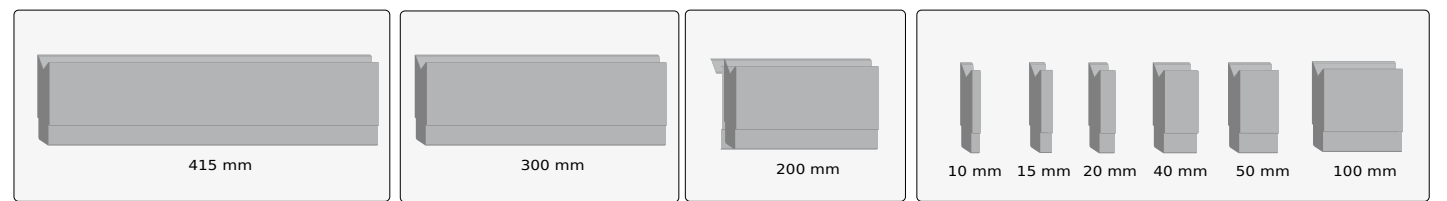

30° Spitzstempel - MT 36

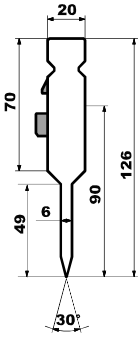

Winkel	30°
Höhe	90.00 mm
Belastung	500 kN/m
Horn Kraft	190 kN/m
Material	
Härte	52 - 56 HRC

Radius 0.2 mm

	Länge	Bestellnummer		Gewicht
Lang	415 mm	36230A	6H MT36230A	5.60 kg
Kurz	300 mm	36230D	6H MT36230D	-
Segmentiert	235 mm	36230F	6H MT36230F	-
Extra kurz	200 mm	36230C	6H MT36230C	-
Horn	100 mm	36230G	6H MT36230G	-

Radius 0.6 mm

	Länge	Bestellnummer		Gewicht
Lang	415 mm	36630A	6H MT36630A	5.60 kg
Kurz	300 mm	36630D	6H MT36630D	-
Segmentiert	235 mm	36630F	6H MT36630F	-
Extra kurz	200 mm	36630C	6H MT36630C	-
Horn	100 mm	36630G	6H MT36630G	-

30° Spitzstempel - MT 36

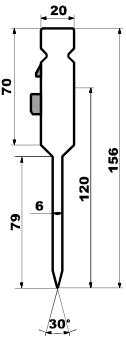

Winkel	30°
Höhe	120.00 mm
Belastung	500 kN/m
Horn Kraft	190 kN/m
Material	
Härte	52 - 56 HRC

Radius 0.2 mm

	Länge	Bestellnummer		Gewicht
Lang	415 mm	36232A	6H MT36232A	6.20 kg
Kurz	300 mm	36232D	6H MT36232D	-
Segmentiert	235 mm	36232F	6H MT36232F	-
Extra kurz	200 mm	36232C	6H MT36232C	-
Horn	100 mm	36232G	6H MT36232G	-

Radius 0.6 mm

	Länge	Bestellnummer		Gewicht
Lang	415 mm	36632A	6H MT36632A	6.20 kg
Kurz	300 mm	36632D	6H MT36632D	-
Segmentiert	235 mm	36632F	6H MT36632F	-
Extra kurz	200 mm	36632C	6H MT36632C	-
Horn	100 mm	36632G	6H MT36632G	-

30° Spitzstempel - MT 36

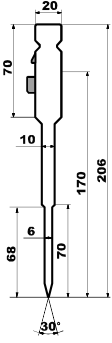

Winkel	30°
Höhe	170.00 mm
Belastung	500 kN/m
Horn Kraft	190 kN/m
Material	
Härte	52 - 56 HRC

Radius 0.2 mm

	Länge	Bestellnummer		Gewicht
Lang	415 mm	36237A	6H MT36237A	8.00 kg
Kurz	300 mm	36237D	6H MT36237D	-
Segmentiert	235 mm	36237F	6H MT36237F	-
Extra kurz	200 mm	36237C	6H MT36237C	-
Horn	100 mm	36237G	6H MT36237G	-

Radius 0.6 mm

	Länge	Bestellnummer		Gewicht
Lang	415 mm	36637A	6H MT36637A	8.00 kg
Kurz	300 mm	36637D	6H MT36637D	-
Segmentiert	235 mm	36637F	6H MT36637F	-
Extra kurz	200 mm	36637C	6H MT36637C	-
Horn	100 mm	36637G	6H MT36637G	-

88° Standardstempel - MT 12

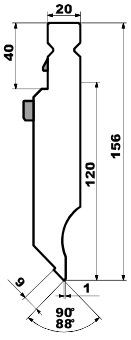

Winkel	88°
Höhe	120.00 mm
Belastung	800 kN/m
Horn Kraft	450 kN/m
Material	
Härte	52 - 56 HRC

Radius 0.2 mm

	Länge	Bestellnummer		Gewicht
Lang	415 mm	12282A	6H MT12282A	11.30 kg
Kurz	300 mm	12282D	6H MT12282D	-
Segmentiert	235 mm	12282F	6H MT12282F	-
Extra kurz	200 mm	12282C	6H MT12282C	-
Horn	100 mm	12282G	6H MT12282G	-

Radius 0.6 mm

	Länge	Bestellnummer		Gewicht
Lang	415 mm	12682A	6H MT12682A	11.30 kg
Kurz	300 mm	12682D	6H MT12682D	-
Segmentiert	235 mm	12682F	6H MT12682F	-
Extra kurz	200 mm	12682C	6H MT12682C	-
Horn	100 mm	12682G	6H MT12682G	-

88° Standardstempel - MT 12

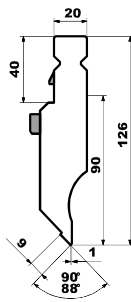

Winkel	88°
Höhe	90.00 mm
Belastung	800 kN/m
Horn Kraft	450 kN/m
Material	
Härte	52 - 56 HRC

Radius 0.2 mm

	Länge	Bestellnummer		Gewicht
Lang	415 mm	12280A	6H MT12280A	8.50 kg
Kurz	300 mm	12280D	6H MT12280D	-
Segmentiert	235 mm	12280F	6H MT12280F	-
Extra kurz	200 mm	12280C	6H MT12280C	-
Horn	100 mm	12280G	6H MT12280G	-

Radius 0.6 mm

	Länge	Bestellnummer		Gewicht
Lang	415 mm	12680A	6H MT12680A	8.50 kg
Kurz	300 mm	12680D	6H MT12680D	-
Segmentiert	235 mm	12680F	6H MT12680F	-
Extra kurz	200 mm	12680C	6H MT12680C	-
Horn	100 mm	12680G	6H MT12680G	-

88° Standardstempel - MT 14

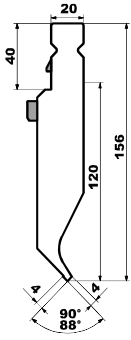

Winkel	88°
Höhe	120.00 mm
Belastung	200 kN/m
Horn Kraft	200 kN/m
Material	
Härte	52 - 56 HRC

Radius 0.2 mm

	Länge	Bestellnummer		Gewicht
Lang	415 mm	14282A	6H MT14282A	10.90 kg
Kurz	300 mm	14282D	6H MT14282D	-
Segmentiert	235 mm	14282F	6H MT14282F	-
Extra kurz	200 mm	14282C	6H MT14282C	-
Horn	100 mm	14282G	6H MT14282G	-

Radius 0.6 mm

	Länge	Bestellnummer		Gewicht
Lang	415 mm	14682A	6H MT14682A	10.90 kg
Kurz	300 mm	14682D	6H MT14682D	-
Segmentiert	235 mm	14682F	6H MT14682F	-
Extra kurz	200 mm	14682C	6H MT14682C	-
Horn	100 mm	14682G	6H MT14682G	-

88° Standardstempel - MT 14

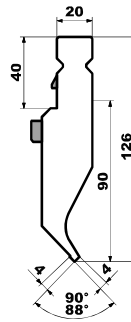

Winkel	88°
Höhe	90.00 mm
Belastung	200 kN/m
Horn Kraft	200 kN/m
Material	
Härte	52 - 56 HRC

Radius 0.2 mm

	Länge	Bestellnummer		Gewicht
Lang	415 mm	14280A	6H MT14280A	8.20 kg
Kurz	300 mm	14280D	6H MT14280D	-
Segmentiert	235 mm	14280F	6H MT14280F	-
Extra kurz	200 mm	14280C	6H MT14280C	-
Horn	100 mm	14280G	6H MT14280G	-

Radius 0.6 mm

	Länge	Bestellnummer		Gewicht
Lang	415 mm	14680A	6H MT14680A	8.20 kg
Kurz	300 mm	14680D	6H MT14680D	-
Segmentiert	235 mm	14680F	6H MT14680F	-
Extra kurz	200 mm	14680C	6H MT14680C	-
Horn	100 mm	14680G	6H MT14680G	-

88° Geißfußstempel - MT 47

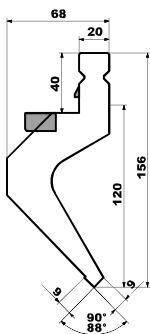

Winkel	88°
Höhe	120.00 mm
Belastung	500 kN/m
Horn Kraft	500 kN/m
Material	
Härte	52 - 56 HRC

Radius 0.2 mm

	Länge	Bestellnummer		Gewicht
Lang	835 mm	1A5211	1A5211	-
Kurz	415 mm	1A5212	1A5212	-
Segmentiert	835 mm	1A521A	1A521A	-

Radius 0.6 mm

	Länge	Bestellnummer		Gewicht
Lang	835 mm	1A5251	1A5251	-
Kurz	415 mm	1A5252	1A5252	-
Segmentiert	835 mm	1A525A	1A525A	-

88° Spitzstempel - MT 30 (Geraderstempel)

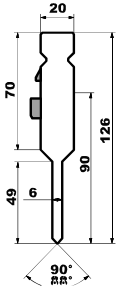

Winkel	88°
Höhe	90.00 mm
Belastung	500 kN/m
Horn Kraft	190 kN/m
Material	
Härte	52 - 56 HRC

Radius 0.2 mm

	Länge	Bestellnummer		Gewicht
Lang	415 mm	30280A	6H MT30280A	5.70 kg
Kurz	300 mm	30280D	6H MT30280D	-
Segmentiert	235 mm	30280F	6H MT30280F	-
Extra kurz	200 mm	30280C	6H MT30280C	-
Horn	100 mm	30280G	6H MT30280G	-

Radius 0.6 mm

	Länge	Bestellnummer		Gewicht
Lang	415 mm	30680A	6H MT30680A	5.70 kg
Kurz	300 mm	30680D	6H MT30680D	-
Segmentiert	235 mm	30680F	6H MT30680F	-
Extra kurz	200 mm	30680C	6H MT30680C	-
Horn	100 mm	30680G	6H MT30680G	-

88° Standardstempel - MT 10

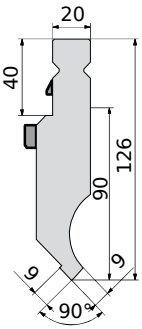

Winkel	88°
Höhe	90.00 mm
Belastung	1000 kN/m
Horn Kraft	450 kN/m
Material	
Härte	52 - 56 HRC

Radius 0.2 mm

	Länge	Bestellnummer		Gewicht
Lang	415 mm	10280A	6H MT10280A	8.60 kg
Kurz	300 mm	10280D	6H MT10280D	-
Segmentiert	235 mm	10280F	6H MT10280F	-
Extra kurz	200 mm	10280C	6H MT10280C	-
Horn	100 mm	10280G	6H MT10280G	-

Radius 0.6 mm

	Länge	Bestellnummer		Gewicht
Lang	415 mm	10680A	6H MT10680A	8.60 kg
Kurz	300 mm	10680D	6H MT10680D	-
Segmentiert	235 mm	10680F	6H MT10680F	-
Extra kurz	200 mm	10680C	6H MT10680C	-
Horn	100 mm	10680G	6H MT10680G	-

88° Standardstempel - MT 28 (gekröpft)

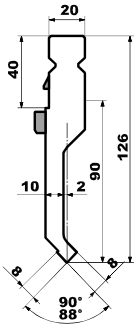

Winkel	88°
Höhe	90.00 mm
Belastung	300 kN/m
Horn Kraft	300 kN/m
Material	
Härte	52 - 56 HRC

Radius 0.2 mm

	Länge	Bestellnummer		Gewicht
Lang	415 mm	28280A	6H MT28280A	5.90 kg
Kurz	300 mm	28280D	6H MT28280D	-
Segmentiert	235 mm	28280F	6H MT28280F	-
Extra kurz	200 mm	28280C	6H MT28280C	-
Horn	100 mm	28280G	6H MT28280G	-

Radius 0.6 mm

	Länge	Bestellnummer		Gewicht
Lang	415 mm	28680A	6H MT28680A	5.90 kg
Kurz	300 mm	28680D	6H MT28680D	-
Segmentiert	235 mm	28680F	6H MT28680F	-
Extra kurz	200 mm	28680C	6H MT28680C	-
Horn	100 mm	28680G	6H MT28680G	-

88° Spitzstempel - MT 30 (Geraderstempel)

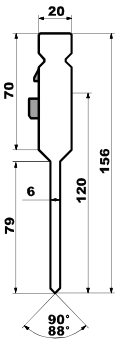

Winkel	88°
Höhe	120.00 mm
Belastung	500 kN/m
Horn Kraft	190 kN/m
Material	
Härte	52 - 56 HRC

Radius 0.2 mm

	Länge	Bestellnummer		Gewicht
Lang	415 mm	30282A	6H MT30282A	6.30 kg
Kurz	300 mm	30282D	6H MT30282D	-
Segmentiert	235 mm	30282F	6H MT30282F	-
Extra kurz	200 mm	30282C	6H MT30282C	-
Horn	100 mm	30282G	6H MT30282G	-

Radius 0.6 mm

	Länge	Bestellnummer		Gewicht
Lang	415 mm	30682A	6H MT30682A	6.30 kg
Kurz	300 mm	30682D	6H MT30682D	-
Segmentiert	235 mm	30682F	6H MT30682F	-
Extra kurz	200 mm	30682C	6H MT30682C	-
Horn	100 mm	30682G	6H MT30682G	-

88° Spitzstempel - MT 30 (Geraderstempel)

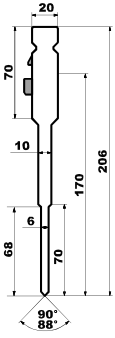

Winkel	88°
Höhe	170.00 mm
Belastung	500 kN/m
Horn Kraft	190 kN/m
Material	
Härte	52 - 56 HRC

Radius 0.2 mm

	Länge	Bestellnummer		Gewicht
Lang	415 mm	30287A	6H MT30287A	8.10 kg
Kurz	300 mm	30287D	6H MT30287D	-
Segmentiert	235 mm	30287F	6H MT30287F	-
Extra kurz	200 mm	30287C	6H MT30287C	-
Horn	100 mm	30287G	6H MT30287G	-

Radius 0.6 mm

	Länge	Bestellnummer		Gewicht
Lang	415 mm	30687A	6H MT30687A	8.10 kg
Kurz	300 mm	30687D	6H MT30687D	-
Segmentiert	235 mm	30687F	6H MT30687F	-
Extra kurz	200 mm	30687C	6H MT30687C	-
Horn	100 mm	30687G	6H MT30687G	-

88° Standardstempel - MT 10

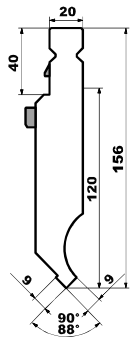

Winkel	88°
Höhe	120.00 mm
Belastung	1000 kN/m
Horn Kraft	450 kN/m
Material	
Härte	52 - 56 HRC

Radius 0.2 mm

	Länge	Bestellnummer		Gewicht
Lang	415 mm	10282A	6H MT10282A	11.40 kg
Kurz	300 mm	10282D	6H MT10282D	-
Segmentiert	235 mm	10282F	6H MT10282F	-
Extra kurz	200 mm	10282C	6H MT10282C	-
Horn	100 mm	10282G	6H MT10282G	-

Radius 0.6 mm

	Länge	Bestellnummer		Gewicht
Lang	415 mm	10682A	6H MT10682A	11.40 kg
Kurz	300 mm	10682D	6H MT10682D	-
Segmentiert	235 mm	10682F	6H MT10682F	-
Extra kurz	200 mm	10682C	6H MT10682C	-
Horn	100 mm	10682G	6H MT10682G	-

88° Standardstempel - MT 28 (gekröpft)

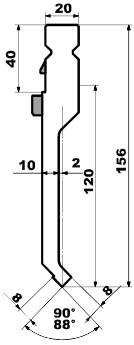

Winkel	88°
Höhe	120.00 mm
Belastung	300 kN/m
Horn Kraft	300 kN/m
Material	
Härte	52 - 56 HRC

Radius 0.2 mm

	Länge	Bestellnummer		Gewicht
Lang	415 mm	28282A	6H MT28282A	6.90 kg
Kurz	300 mm	28282D	6H MT28282D	-
Segmentiert	235 mm	28282F	6H MT28282F	-
Extra kurz	200 mm	28282C	6H MT28282C	-
Horn	100 mm	28282G	6H MT28282G	-

Radius 0.6 mm

	Länge	Bestellnummer		Gewicht
Lang	415 mm	28682A	6H MT28682A	6.90 kg
Kurz	300 mm	28682D	6H MT28682D	-
Segmentiert	235 mm	28682F	6H MT28682F	-
Extra kurz	200 mm	28682C	6H MT28682C	-
Horn	100 mm	28682G	6H MT28682G	-

88° Standardstempel - MT 28 (gekröpft)

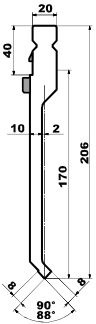

Winkel	88°
Höhe	170.00 mm
Belastung	300 kN/m
Horn Kraft	300 kN/m
Material	
Härte	52 - 56 HRC

Radius 0.2 mm

	Länge	Bestellnummer		Gewicht
Lang	415 mm	28287A	6H MT28287A	8.60 kg
Kurz	300 mm	28287D	6H MT28287D	-
Segmentiert	235 mm	28287F	6H MT28287F	-
Extra kurz	200 mm	28287C	6H MT28287C	-
Horn	100 mm	28287G	6H MT28287G	-

Radius 0.6 mm

	Länge	Bestellnummer		Gewicht
Lang	415 mm	28687A	6H MT28687A	8.60 kg
Kurz	300 mm	28687D	6H MT28687D	-
Segmentiert	235 mm	28687F	6H MT28687F	-
Extra kurz	200 mm	28687C	6H MT28687C	-
Horn	100 mm	28687G	6H MT28687G	-

88° Geißfußstempel - MT 46

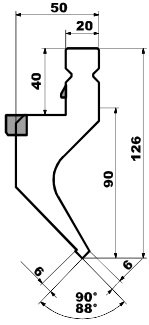

Winkel	88°
Höhe	90.00 mm
Belastung	500 kN/m
Horn Kraft	350 kN/m
Material	
Härte	52 - 56 HRC

Radius 0.2 mm

	Länge	Bestellnummer		Gewicht
Lang	415 mm	46280A	6H MT46280A	9.10 kg
Kurz	300 mm	46280D	6H MT46280D	-
Segmentiert	235 mm	46280F	6H MT46280F	-
Extra kurz	200 mm	46280C	6H MT46280C	-
Horn	100 mm	46280G	6H MT46280G	-

Radius 0.6 mm

	Länge	Bestellnummer		Gewicht
Lang	415 mm	46680A	6H MT46680A	9.10 kg
Kurz	300 mm	46680D	6H MT46680D	-
Segmentiert	235 mm	46680F	6H MT46680F	-
Extra kurz	200 mm	46680C	6H MT46680C	-
Horn	100 mm	46680G	6H MT46680G	-

88° Standardstempel - MT 40

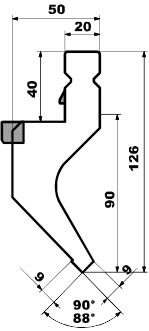

Winkel	88°
Höhe	90.00 mm
Belastung	700 kN/m
Horn Kraft	500 kN/m
Material	
Härte	52 - 56 HRC

Radius 0.2 mm

	Länge	Bestellnummer		Gewicht
Lang	415 mm	40280A	6H MT40280A	9.60 kg
Kurz	300 mm	40280D	6H MT40280D	-
Segmentiert	235 mm	40280F	6H MT40280F	-
Extra kurz	200 mm	40280C	6H MT40280C	-
Horn	100 mm	40280G	6H MT40280G	-

Radius 0.6 mm

	Länge	Bestellnummer		Gewicht
Lang	415 mm	40680A	6H MT40680A	9.60 kg
Kurz	300 mm	40680D	6H MT40680D	-
Segmentiert	235 mm	40680F	6H MT40680F	-
Extra kurz	200 mm	40680C	6H MT40680C	-
Horn	100 mm	40680G	6H MT40680G	-

88° Geißfußstempel - MT 46

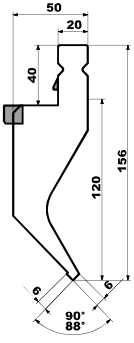

Winkel	88°
Höhe	120.00 mm
Belastung	500 kN/m
Horn Kraft	350 kN/m
Material	
Härte	52 - 56 HRC

Radius 0.2 mm

	Länge	Bestellnummer		Gewicht
Lang	415 mm	46282A	6H MT46282A	13.30 kg
Kurz	300 mm	46282D	6H MT46282D	-
Segmentiert	235 mm	46282F	6H MT46282F	-
Extra kurz	200 mm	46282C	6H MT46282C	-
Horn	100 mm	46282G	6H MT46282G	-

Radius 0.6 mm

	Länge	Bestellnummer		Gewicht
Lang	415 mm	46682A	6H MT46682A	13.30 kg
Kurz	300 mm	46682D	6H MT46682D	-
Segmentiert	235 mm	46682F	6H MT46682F	-
Extra kurz	200 mm	46682C	6H MT46682C	-
Horn	100 mm	46682G	6H MT46682G	-

88° Standardstempel - MT 40

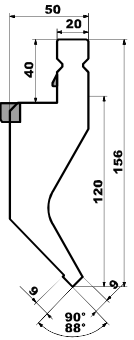

Winkel	88°
Höhe	120.00 mm
Belastung	700 kN/m
Horn Kraft	500 kN/m
Material	
Härte	52 - 56 HRC

Radius 0.2 mm

	Länge	Bestellnummer		Gewicht
Lang	415 mm	40282A	6H MT40282A	13.80 kg
Kurz	300 mm	40282D	6H MT40282D	-
Segmentiert	235 mm	40282F	6H MT40282F	-
Extra kurz	200 mm	40282C	6H MT40282C	-
Horn	100 mm	40282G	6H MT40282G	-

Radius 0.6 mm

	Länge	Bestellnummer		Gewicht
Lang	415 mm	40682A	6H MT40682A	13.80 kg
Kurz	300 mm	40682D	6H MT40682D	-
Segmentiert	235 mm	40682F	6H MT40682F	-
Extra kurz	200 mm	40682C	6H MT40682C	-
Horn	100 mm	40682G	6H MT40682G	-

90° Standardstempel - MT 12

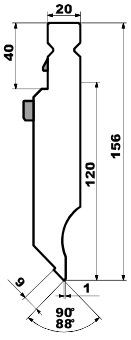

Winkel	90°
Höhe	120.00 mm
Belastung	800 kN/m
Horn Kraft	450 kN/m
Material	
Härte	52 - 56 HRC

Radius 0.2 mm

	Länge	Bestellnummer		Gewicht
Lang	415 mm	12202A	6H MT12202A	11.30 kg
Kurz	300 mm	12202D	6H MT12202D	-
Segmentiert	235 mm	12202F	6H MT12202F	-
Extra kurz	200 mm	12202C	6H MT12202C	-
Horn	100 mm	12202G	6H MT12202G	-

Radius 0.6 mm

	Länge	Bestellnummer		Gewicht
Lang	415 mm	12602A	6H MT12602A	11.30 kg
Kurz	300 mm	12602D	6H MT12602D	-
Segmentiert	235 mm	12602F	6H MT12602F	-
Extra kurz	200 mm	12602C	6H MT12602C	-
Horn	100 mm	12602G	6H MT12602G	-

90° Standardstempel - MT 12

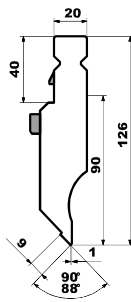

Winkel	90°
Höhe	90.00 mm
Belastung	800 kN/m
Horn Kraft	450 kN/m
Material	
Härte	52 - 56 HRC

Radius 0.2 mm

	Länge	Bestellnummer		Gewicht
Lang	415 mm	12200A	6H MT12200A	8.50 kg
Kurz	300 mm	12200D	6H MT12200D	-
Segmentiert	235 mm	12200F	6H MT12200F	-
Extra kurz	200 mm	12200C	6H MT12200C	-
Horn	100 mm	12200G	6H MT12200G	-

Radius 0.6 mm

	Länge	Bestellnummer		Gewicht
Lang	415 mm	12600A	6H MT12600A	8.50 kg
Kurz	300 mm	12600D	6H MT12600D	-
Segmentiert	235 mm	12600F	6H MT12600F	-
Extra kurz	200 mm	12600C	6H MT12600C	-
Horn	100 mm	12600G	6H MT12600G	-

90° Standardstempel - MT 14

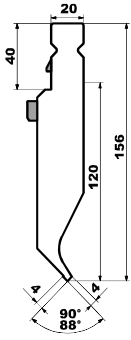

Winkel	90°
Höhe	120.00 mm
Belastung	200 kN/m
Horn Kraft	200 kN/m
Material	
Härte	52 - 56 HRC

Radius 0.2 mm

	Länge	Bestellnummer		Gewicht
Lang	415 mm	14202A	6H MT14202A	10.90 kg
Kurz	300 mm	14202D	6H MT14202D	-
Segmentiert	235 mm	14202F	6H MT14202F	-
Extra kurz	200 mm	14202C	6H MT14202C	-
Horn	100 mm	14202G	6H MT14202G	-

Radius 0.6 mm

	Länge	Bestellnummer		Gewicht
Lang	415 mm	14602A	6H MT14602A	10.90 kg
Kurz	300 mm	14602D	6H MT14602D	-
Segmentiert	235 mm	14602F	6H MT14602F	-
Extra kurz	200 mm	14602C	6H MT14602C	-
Horn	100 mm	14602G	6H MT14602G	-

90° Standardstempel - MT 14

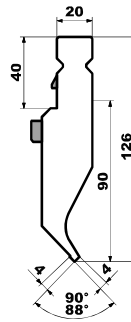

Winkel	90°
Höhe	90.00 mm
Belastung	200 kN/m
Horn Kraft	200 kN/m
Material	
Härte	52 - 56 HRC

Radius 0.2 mm

	Länge	Bestellnummer		Gewicht
Lang	415 mm	14200A	6H MT14200A	8.20 kg
Kurz	300 mm	14200D	6H MT14200D	-
Segmentiert	235 mm	14200F	6H MT14200F	-
Extra kurz	200 mm	14200C	6H MT14200C	-
Horn	100 mm	14200G	6H MT14200G	-

Radius 0.6 mm

	Länge	Bestellnummer		Gewicht
Lang	415 mm	14600A	6H MT14600A	8.20 kg
Kurz	300 mm	14600D	6H MT14600D	-
Segmentiert	235 mm	14600F	6H MT14600F	-
Extra kurz	200 mm	14600C	6H MT14600C	-
Horn	100 mm	14600G	6H MT14600G	-

90° Geißfußstempel - MT 47

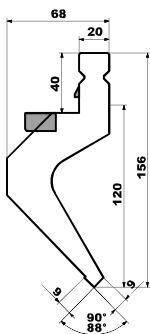

Winkel	90°
Höhe	150.00 mm
Belastung	500 kN/m
Horn Kraft	500 kN/m
Material	
Härte	52 - 56 HRC

Radius 0.2 mm

	Länge	Bestellnummer		Gewicht
Lang	835 mm	1A5111	1A5111	-
Kurz	415 mm	1A5112	1A5112	-
Segmentiert	835 mm	1A511A	1A511A	-

90° Spitzstempel - MT 30 (Geraderstempel)

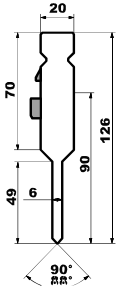

Winkel	90°
Höhe	90.00 mm
Belastung	500 kN/m
Horn Kraft	190 kN/m
Material	
Härte	52 - 56 HRC

Radius 0.2 mm

	Länge	Bestellnummer		Gewicht
Lang	415 mm	30200A	6H MT30200A	5.70 kg
Kurz	300 mm	30200D	6H MT30200D	-
Segmentiert	235 mm	30200F	6H MT30200F	-
Extra kurz	200 mm	30200C	6H MT30200C	-
Horn	100 mm	30200G	6H MT30200G	-

Radius 0.6 mm

	Länge	Bestellnummer		Gewicht
Lang	415 mm	30600A	6H MT30600A	5.70 kg
Kurz	300 mm	30600D	6H MT30600D	-
Segmentiert	235 mm	30600F	6H MT30600F	-
Extra kurz	200 mm	30600C	6H MT30600C	-
Horn	100 mm	30600G	6H MT30600G	-

90° Standardstempel - MT 10

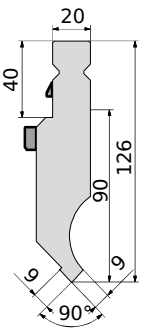

Winkel	90°
Höhe	90.00 mm
Belastung	1000 kN/m
Horn Kraft	450 kN/m
Material	
Härte	52 - 56 HRC

Radius 0.2 mm

	Länge	Bestellnummer		Gewicht
Lang	415 mm	10200A	6H MT10200A	8.60 kg
Kurz	300 mm	10200D	6H MT10200D	-
Segmentiert	235 mm	10200F	6H MT10200F	-
Extra kurz	200 mm	10200C	6H MT10200C	-
Horn	100 mm	10200G	6H MT10200G	-

Radius 0.6 mm

	Länge	Bestellnummer		Gewicht
Lang	415 mm	10600A	6H MT10600A	8.60 kg
Kurz	300 mm	10600D	6H MT10600D	-
Segmentiert	235 mm	10600F	6H MT10600F	-
Extra kurz	200 mm	10600C	6H MT10600C	-
Horn	100 mm	10600G	6H MT10600G	-

90° Standardstempel - MT 28 (gekröpft)

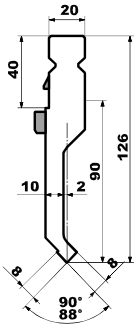

Winkel	90°
Höhe	90.00 mm
Belastung	300 kN/m
Horn Kraft	300 kN/m
Material	
Härte	52 - 56 HRC

Radius 0.2 mm

	Länge	Bestellnummer		Gewicht
Lang	415 mm	28200A	6H MT28200A	5.90 kg
Kurz	300 mm	28200D	6H MT28200D	-
Segmentiert	235 mm	28200F	6H MT28200F	-
Extra kurz	200 mm	28200C	6H MT28200C	-
Horn	100 mm	28200G	6H MT28200G	-

Radius 0.6 mm

	Länge	Bestellnummer		Gewicht
Lang	415 mm	28600A	6H MT28600A	5.90 kg
Kurz	300 mm	28600D	6H MT28600D	-
Segmentiert	235 mm	28600F	6H MT28600F	-
Extra kurz	200 mm	28600C	6H MT28600C	-
Horn	100 mm	28600G	6H MT28600G	-

90° Spitzstempel - MT 30 (Geraderstempel)

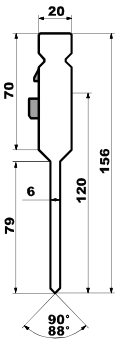

Winkel	90°
Höhe	120.00 mm
Belastung	500 kN/m
Horn Kraft	190 kN/m
Material	
Härte	52 - 56 HRC

Radius 0.2 mm

	Länge	Bestellnummer		Gewicht
Lang	415 mm	30202A	6H MT30202A	6.30 kg
Kurz	300 mm	30202D	6H MT30202D	-
Segmentiert	235 mm	30202F	6H MT30202F	-
Extra kurz	200 mm	30202C	6H MT30202C	-
Horn	100 mm	30202G	6H MT30202G	-

Radius 0.6 mm

	Länge	Bestellnummer		Gewicht
Lang	415 mm	30602A	6H MT30602A	6.30 kg
Kurz	300 mm	30602D	6H MT30602D	-
Segmentiert	235 mm	30602F	6H MT30602F	-
Extra kurz	200 mm	30602C	6H MT30602C	-
Horn	100 mm	30602G	6H MT30602G	-

90° Spitzstempel - MT 30 (Geraderstempel)

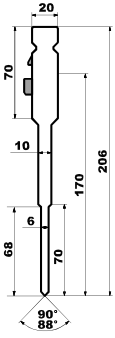

Winkel	90°
Höhe	170.00 mm
Belastung	500 kN/m
Horn Kraft	190 kN/m
Material	
Härte	52 - 56 HRC

Radius 0.2 mm

	Länge	Bestellnummer		Gewicht
Lang	415 mm	30207A	6H MT30207A	8.10 kg
Kurz	300 mm	30207D	6H MT30207D	-
Segmentiert	235 mm	30207F	6H MT30207F	-
Extra kurz	200 mm	30207C	6H MT30207C	-
Horn	100 mm	30207G	6H MT30207G	-

Radius 0.6 mm

	Länge	Bestellnummer		Gewicht
Lang	415 mm	30607A	6H MT30607A	8.10 kg
Kurz	300 mm	30607D	6H MT30607D	-
Segmentiert	235 mm	30607F	6H MT30607F	-
Extra kurz	200 mm	30607C	6H MT30607C	-
Horn	100 mm	30607G	6H MT30607G	-

90° Standardstempel - MT 10

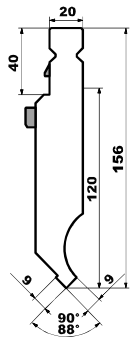

Winkel	90°
Höhe	120.00 mm
Belastung	1000 kN/m
Horn Kraft	450 kN/m
Material	
Härte	52 - 56 HRC

Radius 0.2 mm

	Länge	Bestellnummer		Gewicht
Lang	415 mm	10202A	6H MT10202A	11.40 kg
Kurz	300 mm	10202D	6H MT10202D	-
Segmentiert	235 mm	10202F	6H MT10202F	-
Extra kurz	200 mm	10202C	6H MT10202C	-
Horn	100 mm	10202G	6H MT10202G	-

Radius 0.6 mm

	Länge	Bestellnummer		Gewicht
Lang	415 mm	10602A	6H MT10602A	11.40 kg
Kurz	300 mm	10602D	6H MT10602D	-
Segmentiert	235 mm	10602F	6H MT10602F	-
Extra kurz	200 mm	10602C	6H MT10602C	-
Horn	100 mm	10602G	6H MT10602G	-

90° Standardstempel - MT 28 (gekröpft)

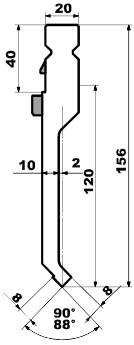

Winkel	90°
Höhe	120.00 mm
Belastung	300 kN/m
Horn Kraft	300 kN/m
Material	
Härte	52 - 56 HRC

Radius 0.2 mm

	Länge	Bestellnummer		Gewicht
Lang	415 mm	28202A	6H MT28202A	6.90 kg
Kurz	300 mm	28202D	6H MT28202D	-
Segmentiert	235 mm	28202F	6H MT28202F	-
Extra kurz	200 mm	28202C	6H MT28202C	-
Horn	100 mm	28202G	6H MT28202G	-

Radius 0.6 mm

	Länge	Bestellnummer		Gewicht
Lang	415 mm	28602A	6H MT28602A	6.90 kg
Kurz	300 mm	28602D	6H MT28602D	-
Segmentiert	235 mm	28602F	6H MT28602F	-
Extra kurz	200 mm	28602C	6H MT28602C	-
Horn	100 mm	28602G	6H MT28602G	-

90° Geißfußstempel - MT 46

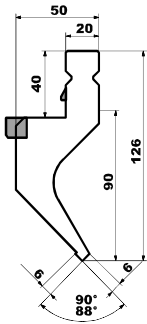

Winkel	90°
Höhe	90.00 mm
Belastung	500 kN/m
Horn Kraft	350 kN/m
Material	
Härte	52 - 56 HRC

Radius 0.2 mm

	Länge	Bestellnummer		Gewicht
Lang	415 mm	46200A	6H MT46200A	9.10 kg
Kurz	300 mm	46200D	6H MT46200D	-
Segmentiert	235 mm	46200F	6H MT46200F	-
Extra kurz	200 mm	46200C	6H MT46200C	-
Horn	100 mm	46200G	6H MT46200G	-

Radius 0.6 mm

	Länge	Bestellnummer		Gewicht
Lang	415 mm	46600A	6H MT46600A	9.10 kg
Kurz	300 mm	46600D	6H MT46600D	-
Segmentiert	235 mm	46600F	6H MT46600F	-
Extra kurz	200 mm	46600C	6H MT46600C	-
Horn	100 mm	46600G	6H MT46600G	-

90° Standardstempel - MT 40

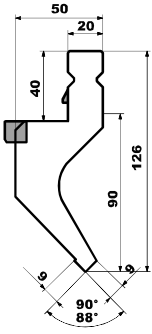

Winkel	90°
Höhe	90.00 mm
Belastung	700 kN/m
Horn Kraft	500 kN/m
Material	
Härte	52 - 56 HRC

Radius 0.2 mm

	Länge	Bestellnummer		Gewicht
Lang	415 mm	40200A	6H MT40200A	9.60 kg
Kurz	300 mm	40200D	6H MT40200D	-
Segmentiert	235 mm	40200F	6H MT40200F	-
Extra kurz	200 mm	40200C	6H MT40200C	-
Horn	100 mm	40200G	6H MT40200G	-

Radius 0.6 mm

	Länge	Bestellnummer		Gewicht
Lang	415 mm	40600A	6H MT40600A	9.60 kg
Kurz	300 mm	40600D	6H MT40600D	-
Segmentiert	235 mm	40600F	6H MT40600F	-
Extra kurz	200 mm	40600C	6H MT40600C	-
Horn	100 mm	40600G	6H MT40600G	-

90° Geißfußstempel - MT 46

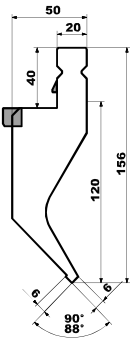

Winkel	90°
Höhe	120.00 mm
Belastung	500 kN/m
Horn Kraft	350 kN/m
Material	
Härte	52 - 56 HRC

Radius 0.2 mm

	Länge	Bestellnummer		Gewicht
Lang	415 mm	46202A	6H MT46202A	13.30 kg
Kurz	300 mm	46202D	6H MT46202D	-
Segmentiert	235 mm	46202F	6H MT46202F	-
Extra kurz	200 mm	46202C	6H MT46202C	-
Horn	100 mm	46202G	6H MT46202G	-

Radius 0.6 mm

	Länge	Bestellnummer		Gewicht
Lang	415 mm	46602A	6H MT46602A	13.30 kg
Kurz	300 mm	46602D	6H MT46602D	-
Segmentiert	235 mm	46602F	6H MT46602F	-
Extra kurz	200 mm	46602C	6H MT46602C	-
Horn	100 mm	46602G	6H MT46602G	-

90° Standardstempel - MT 28 (gekröpft)

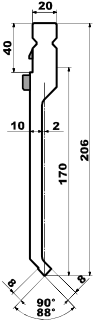

Winkel	90°
Höhe	170.00 mm
Belastung	300 kN/m
Horn Kraft	300 kN/m
Material	
Härte	52 - 56 HRC

Radius 0.2 mm

	Länge	Bestellnummer		Gewicht
Lang	415 mm	28207A	6H MT28207A	8.60 kg
Kurz	300 mm	28207D	6H MT28207D	-
Segmentiert	235 mm	28207F	6H MT28207F	-
Extra kurz	200 mm	28207C	6H MT28207C	-
Horn	100 mm	28207G	6H MT28207G	-

Radius 0.6 mm

	Länge	Bestellnummer		Gewicht
Lang	415 mm	28607A	6H MT28607A	8.60 kg
Kurz	300 mm	28607D	6H MT28607D	-
Segmentiert	235 mm	28607F	6H MT28607F	-
Extra kurz	200 mm	28607C	6H MT28607C	-
Horn	100 mm	28607G	6H MT28607G	-

90° Standardstempel - MT 40

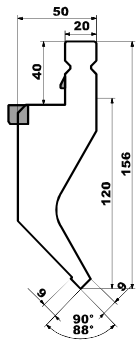

Winkel	90°
Höhe	120.00 mm
Belastung	700 kN/m
Horn Kraft	500 kN/m
Material	
Härte	52 - 56 HRC

Radius 0.2 mm

	Länge	Bestellnummer		Gewicht
Lang	415 mm	40202A	6H MT40202A	13.80 kg
Kurz	300 mm	40202D	6H MT40202D	-
Segmentiert	235 mm	40202F	6H MT40202F	-
Extra kurz	200 mm	40202C	6H MT40202C	-
Horn	100 mm	40202G	6H MT40202G	-

Radius 0.6 mm

	Länge	Bestellnummer		Gewicht
Lang	415 mm	40602A	6H MT40602A	13.80 kg
Kurz	300 mm	40602D	6H MT40602D	-
Segmentiert	235 mm	40602F	6H MT40602F	-
Extra kurz	200 mm	40602C	6H MT40602C	-
Horn	100 mm	40602G	6H MT40602G	-

1V Matrize - (V6 / 30°)

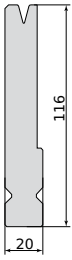

	V6 x 30° / (R 1.00 mm)
Höhe	116.00 mm
Breite	17.00 mm
Belastung	180 kN/m
Material	
Härte	52 - 56 HRC Unbehandelt
Installation	Stecksystem

	Länge	Bestellnummer		Gewicht
Lang	415 mm	50638E	6H MT50638E	6.60 kg
Kurz	300 mm	50638D	6H MT50638D	-
Segmentiert	235 mm	50638F	6H MT50638F	-
Extra kurz	200 mm	50638C	6H MT50638C	-

1V Matrize - (V8 / 30°)

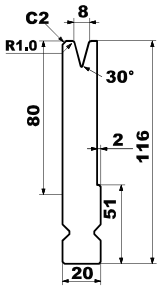

	V8 x 30° / (R 1.00 mm)
Höhe	116.00 mm
Breite	18.00 mm
Belastung	200 kN/m
Material	
Härte	52 - 56 HRC Unbehandelt
Installation	Stecksystem

	Länge	Bestellnummer		Gewicht
Lang	415 mm	50838E	6H MT50838E	6.80 kg
Kurz	300 mm	50838D	6H MT50838D	-
Segmentiert	235 mm	50838F	6H MT50838F	-
Extra kurz	200 mm	50838C	6H MT50838C	-

1V Matrize - (V10 / 30°)

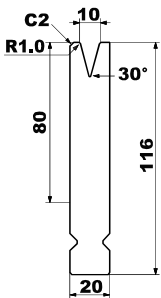

	V10 x 30° / (R 1.00 mm)
Höhe	116.00 mm
Breite	20.00 mm
Belastung	260 kN/m
Material	
Härte	52 - 56 HRC Unbehandelt
Installation	Stecksystem

	Länge	Bestellnummer		Gewicht
Lang	415 mm	51038E	6H MT51038E	7.10 kg
Kurz	300 mm	51038D	6H MT51038D	-
Segmentiert	235 mm	51038F	6H MT51038F	-
Extra kurz	200 mm	51038C	6H MT51038C	-

1V Matrize - (V4 / 88°)

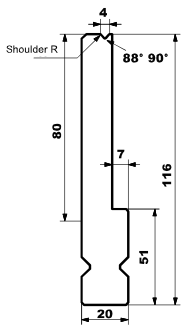

	V4 x 88° / (R 0.00 mm)
Höhe	116.00 mm
Breite	13.00 mm
Belastung	400 kN/m
Material	
Härte	52 - 56 HRC Unbehandelt
Installation	Stecksystem

	Länge	Bestellnummer		Gewicht
Lang	415 mm	60488E	6H MT60488E	5.70 kg
Kurz	300 mm	60488D	6H MT60488D	-
Segmentiert	235 mm	60488F	6H MT60488F	-
Extra kurz	200 mm	60488C	6H MT60488C	-

1V Matrize - (V4 / 88°)

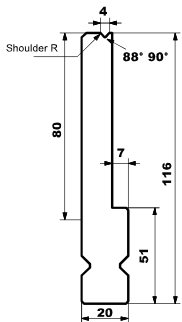

	V4 x 88° / (R 1.00 mm)
Höhe	116.00 mm
Breite	13.00 mm
Belastung	400 kN/m
Material	
Härte	52 - 56 HRC Unbehandelt
Installation	Stecksystem

	Länge	Bestellnummer		Gewicht
Lang	415 mm	70488E	6H MT70488E	5.70 kg
Kurz	300 mm	70488D	6H MT70488D	-
Segmentiert	235 mm	70488F	6H MT70488F	-
Extra kurz	200 mm	70488C	6H MT70488C	-

1V Matrize - (V5 / 88°)

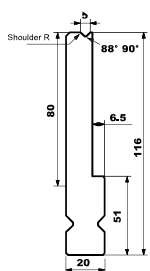

	V5 x 88° / (R 0.00 mm)
Höhe	116.00 mm
Breite	13.50 mm
Belastung	500 kN/m
Material	
Härte	52 - 56 HRC Unbehandelt
Installation	Stecksystem

	Länge	Bestellnummer		Gewicht
Lang	415 mm	60588E	6H MT60588E	5.80 kg
Kurz	300 mm	60588D	6H MT60588D	-
Segmentiert	235 mm	60588F	6H MT60588F	-
Extra kurz	200 mm	60588C	6H MT60588C	-

1V Matrize - (V5 / 88°)

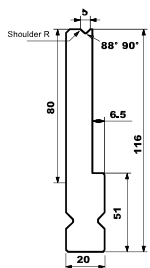

	V5 x 88° / (R 1.00 mm)
Höhe	116.00 mm
Breite	13.50 mm
Belastung	500 kN/m
Material	
Härte	52 - 56 HRC Unbehandelt
Installation	Stecksystem

	Länge	Bestellnummer		Gewicht
Lang	415 mm	70588E	6H MT70588E	5.80 kg
Kurz	300 mm	70588D	6H MT70588D	-
Segmentiert	235 mm	70588F	6H MT70588F	-
Extra kurz	200 mm	70588C	6H MT70588C	-

1V Matrize - (V6 / 88°)

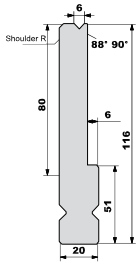

	V6 x 88° / (R 0.00 mm)
Höhe	116.00 mm
Breite	14.00 mm
Belastung	550 kN/m
Material	
Härte	52 - 56 HRC Unbehandelt
Installation	Stecksystem

	Länge	Bestellnummer		Gewicht
Lang	415 mm	60688E	6H MT60688E	6.00 kg
Kurz	300 mm	60688D	6H MT60688D	-
Segmentiert	235 mm	60688F	6H MT60688F	-
Extra kurz	200 mm	60688C	6H MT60688C	-

1V Matrize - (V6 / 88°)

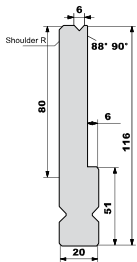

	V6 x 88° / (R 1.00 mm)
Höhe	116.00 mm
Breite	14.00 mm
Belastung	550 kN/m
Material	
Härte	52 - 56 HRC Unbehandelt
Installation	Stecksystem

	Länge	Bestellnummer		Gewicht
Lang	415 mm	70688E	6H MT70688E	6.00 kg
Kurz	300 mm	70688D	6H MT70688D	-
Segmentiert	235 mm	70688F	6H MT70688F	-
Extra kurz	200 mm	70688C	6H MT70688C	-

1V Matrize - (V7 / 88°)

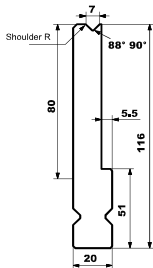

	V7 x 88° / (R 0.00 mm)
Höhe	116.00 mm
Breite	14.50 mm
Belastung	600 kN/m
Material	
Härte	52 - 56 HRC Unbehandelt
Installation	Stecksystem

	Länge	Bestellnummer		Gewicht
Lang	415 mm	60788E	6H MT60788E	6.10 kg
Kurz	300 mm	60788D	6H MT60788D	-
Segmentiert	235 mm	60788F	6H MT60788F	-
Extra kurz	200 mm	60788C	6H MT60788C	-

1V Matrize - (V7 / 88°)

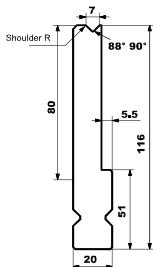

	V7 x 88° / (R 1.00 mm)
Höhe	116.00 mm
Breite	14.50 mm
Belastung	600 kN/m
Material	
Härte	52 - 56 HRC Unbehandelt
Installation	Stecksystem

	Länge	Bestellnummer		Gewicht
Lang	415 mm	70788E	6H MT70788E	6.10 kg
Kurz	300 mm	70788D	6H MT70788D	-
Segmentiert	235 mm	70788F	6H MT70788F	-
Extra kurz	200 mm	70788C	6H MT70788C	-

1V Matrize - (V8 / 88°)

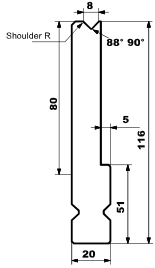

	V8 x 88° / (R 0.00 mm)
Höhe	116.00 mm
Breite	15.00 mm
Belastung	650 kN/m
Material	
Härte	52 - 56 HRC Unbehandelt
Installation	Stecksystem

	Länge	Bestellnummer		Gewicht
Lang	415 mm	60888E	6H MT60888E	6.20 kg
Kurz	300 mm	60888D	6H MT60888D	-
Segmentiert	235 mm	60888F	6H MT60888F	-
Extra kurz	200 mm	60888C	6H MT60888C	-

1V Matrize - (V8 / 88°)

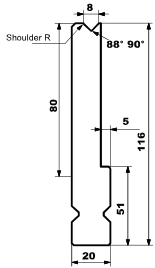

	V8 x 88° / (R 1.00 mm)
Höhe	116.00 mm
Breite	15.00 mm
Belastung	650 kN/m
Material	
Härte	52 - 56 HRC Unbehandelt
Installation	Stecksystem

	Länge	Bestellnummer		Gewicht
Lang	415 mm	70888E	6H MT70888E	6.20 kg
Kurz	300 mm	70888D	6H MT70888D	-
Segmentiert	235 mm	70888F	6H MT70888F	-
Extra kurz	200 mm	70888C	6H MT70888C	-

1V Matrize - (V10 / 88°)

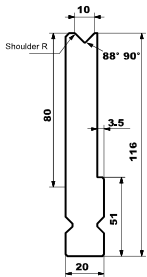

	V10 x 88° / (R 0.00 mm)
Höhe	116.00 mm
Breite	16.50 mm
Belastung	900 kN/m
Material	
Härte	52 - 56 HRC Unbehandelt
Installation	Stecksystem

	Länge	Bestellnummer		Gewicht
Lang	415 mm	61088E	6H MT61088E	6.50 kg
Kurz	300 mm	61088D	6H MT61088D	-
Segmentiert	235 mm	61088F	6H MT61088F	-
Extra kurz	200 mm	61088C	6H MT61088C	-

1V Matrize - (V10 / 88°)

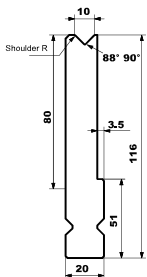

	V10 x 88° / (R 2.00 mm)
Höhe	116.00 mm
Breite	16.50 mm
Belastung	900 kN/m
Material	
Härte	52 - 56 HRC Unbehandelt
Installation	Stecksystem

	Länge	Bestellnummer		Gewicht
Lang	415 mm	71088E	6H MT71088E	6.50 kg
Kurz	300 mm	71088D	6H MT71088D	-
Segmentiert	235 mm	71088F	6H MT71088F	-
Extra kurz	200 mm	71088C	6H MT71088C	-

1V Matrize - (V12 / 88°)

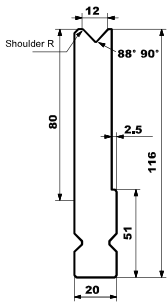

	V12 x 88° / (R 0.00 mm)
Höhe	116.00 mm
Breite	17.50 mm
Belastung	1000 kN/m
Material	
Härte	52 - 56 HRC Unbehandelt
Installation	Stecksystem

	Länge	Bestellnummer		Gewicht
Lang	415 mm	61288E	6H MT61288E	6.70 kg
Kurz	300 mm	61288D	6H MT61288D	-
Segmentiert	235 mm	61288F	6H MT61288F	-
Extra kurz	200 mm	61288C	6H MT61288C	-

1V Matrize - (V12 / 88°)

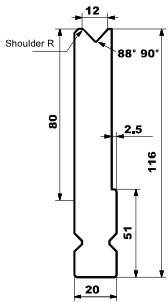

	V12 x 88° / (R 2.00 mm)
Höhe	116.00 mm
Breite	17.50 mm
Belastung	1000 kN/m
Material	
Härte	52 - 56 HRC Unbehandelt
Installation	Stecksystem

	Länge	Bestellnummer		Gewicht
Lang	415 mm	71288E	6H MT71288E	6.70 kg
Kurz	300 mm	71288D	6H MT71288D	-
Segmentiert	235 mm	71288F	6H MT71288F	-
Extra kurz	200 mm	71288C	6H MT71288C	-

1V Matrize - (V14 / 88°)

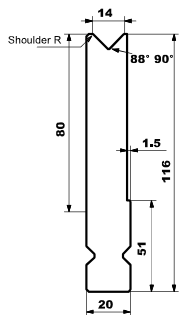

	V14 x 88° / (R 0.00 mm)
Höhe	116.00 mm
Breite	18.50 mm
Belastung	1000 kN/m
Material	
Härte	52 - 56 HRC Unbehandelt
Installation	Stecksystem

	Länge	Bestellnummer		Gewicht
Lang	415 mm	61488E	6H MT61488E	6.90 kg
Kurz	300 mm	61488D	6H MT61488D	-
Segmentiert	235 mm	61488F	6H MT61488F	-
Extra kurz	200 mm	61488C	6H MT61488C	-

1V Matrize - (V14 / 88°)

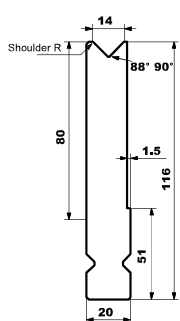

	V14 x 88° / (R 2.00 mm)
Höhe	116.00 mm
Breite	18.50 mm
Belastung	1000 kN/m
Material	
Härte	52 - 56 HRC Unbehandelt
Installation	Stecksystem

	Länge	Bestellnummer		Gewicht
Lang	415 mm	71488E	6H MT71488E	6.90 kg
Kurz	300 mm	71488D	6H MT71488D	-
Segmentiert	235 mm	71488F	6H MT71488F	-
Extra kurz	200 mm	71488C	6H MT71488C	-

1V Matrize - (V16 / 88°)

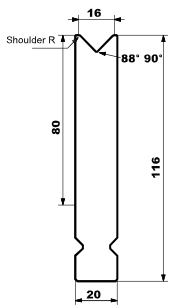

	V16 x 88° / (R 0.00 mm)
Höhe	116.00 mm
Breite	20.00 mm
Belastung	1000 kN/m
Material	
Härte	52 - 56 HRC Unbehandelt
Installation	Stecksystem

	Länge	Bestellnummer		Gewicht
Lang	415 mm	61688E	6H MT61688E	7.20 kg
Kurz	300 mm	61688D	6H MT61688D	-
Segmentiert	235 mm	61688F	6H MT61688F	-
Extra kurz	200 mm	61688C	6H MT61688C	-

1V Matrize - (V16 / 88°)

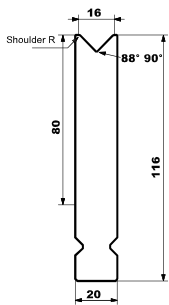

	V16 x 88° / (R 2.00 mm)
Höhe	116.00 mm
Breite	20.00 mm
Belastung	1000 kN/m
Material	
Härte	52 - 56 HRC Unbehandelt
Installation	Stecksystem

	Länge	Bestellnummer		Gewicht
Lang	415 mm	71688E	6H MT71688E	7.20 kg
Kurz	300 mm	71688D	6H MT71688D	-
Segmentiert	235 mm	71688F	6H MT71688F	-
Extra kurz	200 mm	71688C	6H MT71688C	-

1V Matrize - (V18 / 88°)

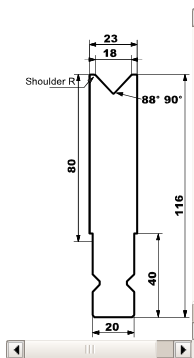

	V18 x 88° / (R 1.00 mm)
Höhe	116.00 mm
Breite	23.00 mm
Belastung	1000 kN/m
Material	
Härte	52 - 56 HRC Unbehandelt
Installation	Stecksystem

	Länge	Bestellnummer		Gewicht
Lang	415 mm	61888E	6H MT61888E	7.90 kg
Kurz	300 mm	61888D	6H MT61888D	-
Segmentiert	235 mm	61888F	6H MT61888F	-
Extra kurz	200 mm	61888C	6H MT61888C	-

1V Matrize - (V18 / 88°)

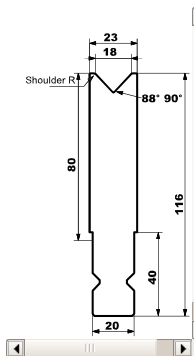

	V18 x 88° / (R 2.00 mm)
Höhe	116.00 mm
Breite	23.00 mm
Belastung	1000 kN/m
Material	
Härte	52 - 56 HRC Unbehandelt
Installation	Stecksystem

	Länge	Bestellnummer		Gewicht
Lang	415 mm	71888E	6H MT71888E	7.90 kg
Kurz	300 mm	71888D	6H MT71888D	-
Segmentiert	235 mm	71888F	6H MT71888F	-
Extra kurz	200 mm	71888C	6H MT71888C	-

1V Matrize - (V20 / 88°)

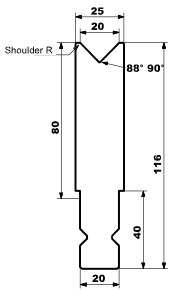

	V20 x 88° / (R 1.00 mm)
Höhe	116.00 mm
Breite	25.00 mm
Belastung	1000 kN/m
Material	
Härte	52 - 56 HRC Unbehandelt
Installation	Stecksystem

	Länge	Bestellnummer		Gewicht
Lang	415 mm	62088E	6H MT62088E	8.30 kg
Kurz	300 mm	62088D	6H MT62088D	-
Segmentiert	235 mm	62088F	6H MT62088F	-
Extra kurz	200 mm	62088C	6H MT62088C	-

1V Matrize - (V20 / 88°)

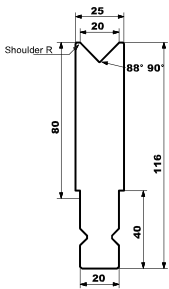

	V20 x 88° / (R 3.00 mm)
Höhe	116.00 mm
Breite	25.00 mm
Belastung	1000 kN/m
Material	
Härte	52 - 56 HRC Unbehandelt
Installation	Stecksystem

	Länge	Bestellnummer		Gewicht
Lang	415 mm	72088E	6H MT72088E	8.30 kg
Kurz	300 mm	72088D	6H MT72088D	-
Segmentiert	235 mm	72088F	6H MT72088F	-
Extra kurz	200 mm	72088C	6H MT72088C	-

1V Matrize - (V25 / 88°)

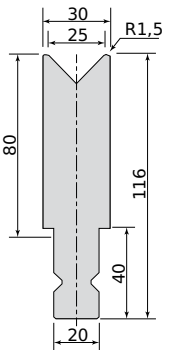

	V25 x 88° / (R 1.00 mm)
Höhe	116.00 mm
Breite	30.00 mm
Belastung	1000 kN/m
Material	
Härte	52 - 56 HRC Unbehandelt
Installation	Stecksystem

	Länge	Bestellnummer		Gewicht
Lang	415 mm	62588E	6H MT62588E	9.40 kg
Kurz	300 mm	62588D	6H MT62588D	-
Segmentiert	235 mm	62588F	6H MT62588F	-
Extra kurz	200 mm	62588C	6H MT62588C	-

1V Matrize - (V25 / 88°)

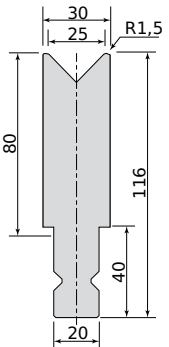

	V25 x 88° / (R 3.00 mm)
Höhe	116.00 mm
Breite	30.00 mm
Belastung	1000 kN/m
Material	
Härte	52 - 56 HRC Unbehandelt
Installation	Stecksystem

	Länge	Bestellnummer		Gewicht
Lang	415 mm	72588E	6H MT72588E	9.40 kg
Kurz	300 mm	72588D	6H MT72588D	-
Segmentiert	235 mm	72588F	6H MT72588F	-
Extra kurz	200 mm	72588C	6H MT72588C	-

1V Matrize - (V4 / 90°)

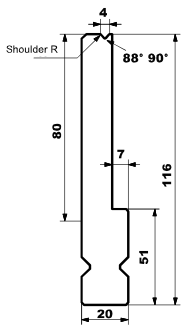

	V4 x 90° / (R 0.00 mm)
Höhe	116.00 mm
Breite	13.00 mm
Belastung	400 kN/m
Material	
Härte	52 - 56 HRC Unbehandelt
Installation	Stecksystem

	Länge	Bestellnummer		Gewicht
Lang	415 mm	60408E	6H MT60408E	5.70 kg
Kurz	300 mm	60408D	6H MT60408D	-
Segmentiert	235 mm	60408F	6H MT60408F	-
Extra kurz	200 mm	60408C	6H MT60408C	-

1V Matrize - (V4 / 90°)

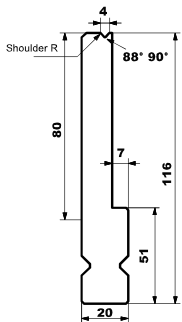

	V4 x 90° / (R 1.00 mm)
Höhe	116.00 mm
Breite	13.00 mm
Belastung	400 kN/m
Material	
Härte	52 - 56 HRC Unbehandelt
Installation	Stecksystem

	Länge	Bestellnummer		Gewicht
Lang	415 mm	70408E	6H MT70408E	5.70 kg
Kurz	300 mm	70408D	6H MT70408D	-
Segmentiert	235 mm	70408F	6H MT70408F	-
Extra kurz	200 mm	70408C	6H MT70408C	-

1V Matrize - (V5 / 90°)

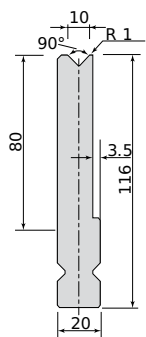

	V5 x 90° / (R 0.00 mm)
Höhe	116.00 mm
Breite	13.50 mm
Belastung	500 kN/m
Material	
Härte	52 - 56 HRC Unbehandelt
Installation	Stecksystem

	Länge	Bestellnummer		Gewicht
Lang	415 mm	60508E	6H MT60508E	5.80 kg
Kurz	300 mm	60508D	6H MT60508D	-
Segmentiert	235 mm	60508F	6H MT60508F	-
Extra kurz	200 mm	60508C	6H MT60508C	-

1V Matrize - (V5 / 90°)

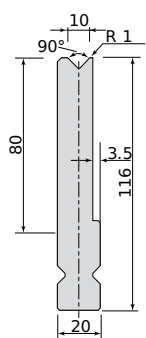

	V5 x 90° / (R 1.00 mm)
Höhe	116.00 mm
Breite	13.50 mm
Belastung	500 kN/m
Material	
Härte	52 - 56 HRC Unbehandelt
Installation	Stecksystem

	Länge	Bestellnummer		Gewicht
Lang	415 mm	70508E	6H MT70508E	5.80 kg
Kurz	300 mm	70508D	6H MT70508D	-
Segmentiert	235 mm	70508F	6H MT70508F	-
Extra kurz	200 mm	70508C	6H MT70508C	-

1V Matrize - (V6 / 90°)

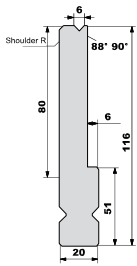

	V6 x 90° / (R 0.00 mm)
Höhe	116.00 mm
Breite	14.00 mm
Belastung	550 kN/m
Material	
Härte	52 - 56 HRC Unbehandelt
Installation	Stecksystem

	Länge	Bestellnummer		Gewicht
Lang	415 mm	60608E	6H MT60608E	6.00 kg
Kurz	300 mm	60608D	6H MT60608D	-
Segmentiert	235 mm	60608F	6H MT60608F	-
Extra kurz	200 mm	60608C	6H MT60608C	-

1V Matrize - (V6 / 90°)

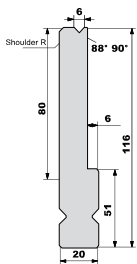

	V6 x 90° / (R 1.00 mm)
Höhe	116.00 mm
Breite	14.00 mm
Belastung	550 kN/m
Material	
Härte	52 - 56 HRC Unbehandelt
Installation	Stecksystem

	Länge	Bestellnummer		Gewicht
Lang	415 mm	70608E	6H MT70608E	6.00 kg
Kurz	300 mm	70608D	6H MT70608D	-
Segmentiert	235 mm	70608F	6H MT70608F	-
Extra kurz	200 mm	70608C	6H MT70608C	-

1V Matrize - (V7 / 90°)

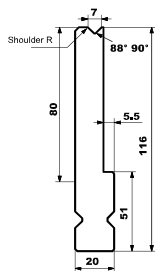

	V7 x 90° / (R 0.00 mm)
Höhe	116.00 mm
Breite	14.50 mm
Belastung	600 kN/m
Material	
Härte	52 - 56 HRC Unbehandelt
Installation	Stecksystem

	Länge	Bestellnummer		Gewicht
Lang	415 mm	60708E	6H MT60708E	6.10 kg
Kurz	300 mm	60708D	6H MT60708D	-
Segmentiert	235 mm	60708F	6H MT60708F	-
Extra kurz	200 mm	60708C	6H MT60708C	-

1V Matrize - (V7 / 90°)

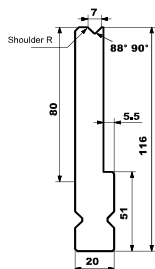

	V7 x 90° / (R 1.00 mm)
Höhe	116.00 mm
Breite	14.50 mm
Belastung	600 kN/m
Material	
Härte	52 - 56 HRC Unbehandelt
Installation	Stecksystem

	Länge	Bestellnummer		Gewicht
Lang	415 mm	70708E	6H MT70708E	6.10 kg
Kurz	300 mm	70708D	6H MT70708D	-
Segmentiert	235 mm	70708F	6H MT70708F	-
Extra kurz	200 mm	70708C	6H MT70708C	-

1V Matrize - (V8 / 90°)

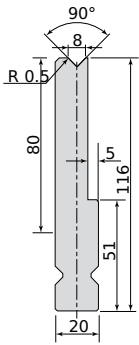

	V8 x 90° / (R 0.00 mm)
Höhe	116.00 mm
Breite	15.00 mm
Belastung	650 kN/m
Material	
Härte	52 - 56 HRC Unbehandelt
Installation	Stecksystem

	Länge	Bestellnummer		Gewicht
Lang	415 mm	60808E	6H MT60808E	6.20 kg
Kurz	300 mm	60808D	6H MT60808D	-
Segmentiert	235 mm	60808F	6H MT60808F	-
Extra kurz	200 mm	60808C	6H MT60808C	-

1V Matrize - (V8 / 90°)

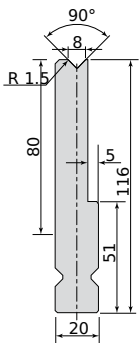

	V8 x 90° / (R 1.00 mm)
Höhe	116.00 mm
Breite	15.00 mm
Belastung	650 kN/m
Material	
Härte	52 - 56 HRC Unbehandelt
Installation	Stecksystem

	Länge	Bestellnummer		Gewicht
Lang	415 mm	70808E	6H MT70808E	6.20 kg
Kurz	300 mm	70808D	6H MT70808D	-
Segmentiert	235 mm	70808F	6H MT70808F	-
Extra kurz	200 mm	70808C	6H MT70808C	-

1V Matrize - (V10 / 90°)

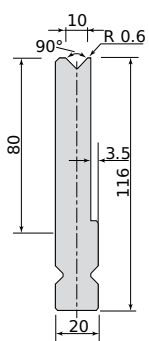

	V10 x 90° / (R 0.00 mm)
Höhe	116.00 mm
Breite	16.50 mm
Belastung	900 kN/m
Material	
Härte	52 - 56 HRC Unbehandelt
Installation	Stecksystem

	Länge	Bestellnummer		Gewicht
Lang	415 mm	61008E	6H MT61008E	6.50 kg
Kurz	300 mm	61008D	6H MT61008D	-
Segmentiert	235 mm	61008F	6H MT61008F	-
Extra kurz	200 mm	61008C	6H MT61008C	-

1V Matrize - (V10 / 90°)

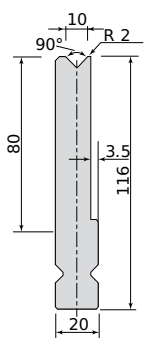

	V10 x 90° / (R 2.00 mm)
Höhe	116.00 mm
Breite	16.50 mm
Belastung	900 kN/m
Material	
Härte	52 - 56 HRC Unbehandelt
Installation	Stecksystem

	Länge	Bestellnummer		Gewicht
Lang	415 mm	71008E	6H MT71008E	6.50 kg
Kurz	300 mm	71008D	6H MT71008D	-
Segmentiert	235 mm	71008F	6H MT71008F	-
Extra kurz	200 mm	71008C	6H MT71008C	-

1V Matrize - (V12 / 90°)

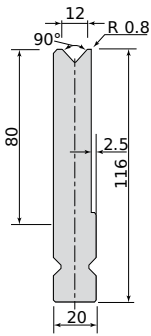

	V12 x 90° / (R 0.00 mm)
Höhe	116.00 mm
Breite	17.50 mm
Belastung	1000 kN/m
Material	
Härte	52 - 56 HRC Unbehandelt
Installation	Stecksystem

	Länge	Bestellnummer		Gewicht
Lang	415 mm	61208E	6H MT61208E	6.70 kg
Kurz	300 mm	61208D	6H MT61208D	-
Segmentiert	235 mm	61208F	6H MT61208F	-
Extra kurz	200 mm	61208C	6H MT61208C	-

1V Matrize - (V12 / 90°)

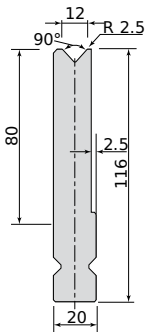

	V12 x 90° / (R 2.00 mm)
Höhe	116.00 mm
Breite	17.50 mm
Belastung	1000 kN/m
Material	
Härte	52 - 56 HRC Unbehandelt
Installation	Stecksystem

	Länge	Bestellnummer		Gewicht
Lang	415 mm	71208E	6H MT71208E	6.70 kg
Kurz	300 mm	71208D	6H MT71208D	-
Segmentiert	235 mm	71208F	6H MT71208F	-
Extra kurz	200 mm	71208C	6H MT71208C	-

1V Matrize - (V14 / 90°)

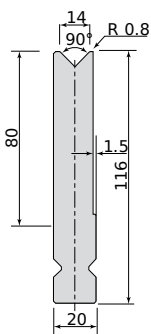

	V14 x 90° / (R 0.00 mm)
Höhe	116.00 mm
Breite	18.50 mm
Belastung	1000 kN/m
Material	
Härte	52 - 56 HRC Unbehandelt
Installation	Stecksystem

	Länge	Bestellnummer		Gewicht
Lang	415 mm	61408E	6H MT61408E	6.90 kg
Kurz	300 mm	61408D	6H MT61408D	-
Segmentiert	235 mm	61408F	6H MT61408F	-
Extra kurz	200 mm	61408C	6H MT61408C	-

1V Matrize - (V14 / 90°)

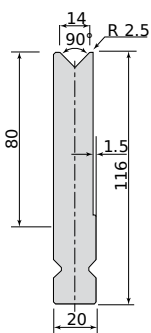

	V14 x 90° / (R 2.00 mm)
Höhe	116.00 mm
Breite	0.00 mm
Belastung	1000 kN/m
Material	
Härte	52 - 56 HRC Unbehandelt
Installation	Stecksystem

	Länge	Bestellnummer		Gewicht
Lang	415 mm	71408E	6H MT71408E	6.90 kg
Kurz	300 mm	71408D	6H MT71408D	-
Segmentiert	235 mm	71408F	6H MT71408F	-
Extra kurz	200 mm	71408C	6H MT71408C	-

1V Matrize - (V16 / 90°)

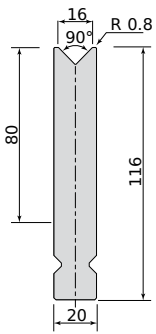

	V16 x 90° / (R 0.00 mm)
Höhe	116.00 mm
Breite	20.00 mm
Belastung	1000 kN/m
Material	
Härte	52 - 56 HRC Unbehandelt
Installation	Stecksystem

	Länge	Bestellnummer		Gewicht
Lang	415 mm	61608E	6H MT61608E	7.20 kg
Kurz	300 mm	61608D	6H MT61608D	-
Segmentiert	235 mm	61608F	6H MT61608F	-
Extra kurz	200 mm	61608C	6H MT61608C	-

1V Matrize - (V16 / 90°)

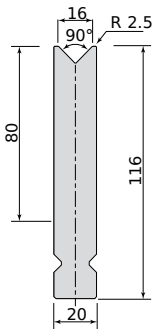

	V16 x 90° / (R 2.00 mm)
Höhe	116.00 mm
Breite	20.00 mm
Belastung	1000 kN/m
Material	
Härte	52 - 56 HRC Unbehandelt
Installation	Stecksystem

	Länge	Bestellnummer		Gewicht
Lang	415 mm	71608E	6H MT71608E	7.20 kg
Kurz	300 mm	71608D	6H MT71608D	-
Segmentiert	235 mm	71608F	6H MT71608F	-
Extra kurz	200 mm	71608C	6H MT71608C	-

1V Matrize - (V18 / 90°)

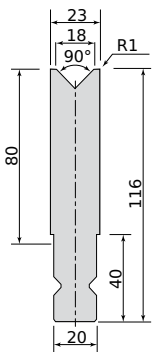

	V18 x 90° / (R 1.00 mm)
Höhe	116.00 mm
Breite	23.00 mm
Belastung	1000 kN/m
Material	
Härte	52 - 56 HRC Unbehandelt
Installation	Stecksystem

	Länge	Bestellnummer		Gewicht
Lang	415 mm	61808E	6H MT61808E	7.90 kg
Kurz	300 mm	61808D	6H MT61808D	-
Segmentiert	235 mm	61808F	6H MT61808F	-
Extra kurz	200 mm	61808C	6H MT61808C	-

1V Matrize - (V18 / 90°)

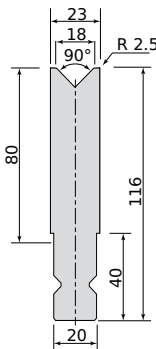

	V18 x 90° / (R 2.00 mm)
Höhe	116.00 mm
Breite	23.00 mm
Belastung	1000 kN/m
Material	
Härte	52 - 56 HRC Unbehandelt
Installation	Stecksystem

	Länge	Bestellnummer		Gewicht
Lang	415 mm	71808E	6H MT71808E	7.90 kg
Kurz	300 mm	71808D	6H MT71808D	-
Segmentiert	235 mm	71808F	6H MT71808F	-
Extra kurz	200 mm	71808C	6H MT71808C	-

1V Matrize - (V20 / 90°)

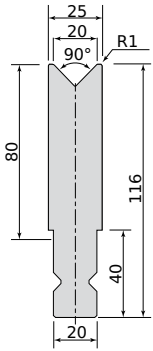

	V20 x 90° / (R 1.00 mm)
Höhe	116.00 mm
Breite	25.00 mm
Belastung	1000 kN/m
Material	
Härte	52 - 56 HRC Unbehandelt
Installation	Stecksystem

	Länge	Bestellnummer		Gewicht
Lang	415 mm	62008E	6H MT62008E	8.30 kg
Kurz	300 mm	62008D	6H MT62008D	-
Segmentiert	235 mm	62008F	6H MT62008F	-
Extra kurz	200 mm	62008C	6H MT62008C	-

1V Matrize - (V20 / 90°)

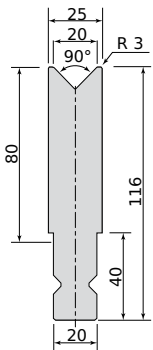

	V20 x 90° / (R 3.00 mm)
Höhe	116.00 mm
Breite	25.00 mm
Belastung	1000 kN/m
Material	
Härte	52 - 56 HRC Unbehandelt
Installation	Stecksystem

	Länge	Bestellnummer		Gewicht
Lang	415 mm	72008E	6H MT72008E	8.30 kg
Kurz	300 mm	72008D	6H MT72008D	-
Segmentiert	235 mm	72008F	6H MT72008F	-
Extra kurz	200 mm	72008C	6H MT72008C	-

1V Matrize - (V25 / 90°)

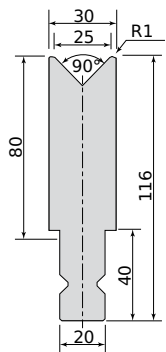

	V25 x 90° / (R 1.00 mm)
Höhe	116.00 mm
Breite	30.00 mm
Belastung	1000 kN/m
Material	
Härte	52 - 56 HRC Unbehandelt
Installation	Stecksystem

	Länge	Bestellnummer		Gewicht
Lang	415 mm	62508E	6H MT62508E	9.40 kg
Kurz	300 mm	62508D	6H MT62508D	-
Segmentiert	235 mm	62508F	6H MT62508F	-
Extra kurz	200 mm	62508C	6H MT62508C	-

1V Matrize - (V25 / 90°)

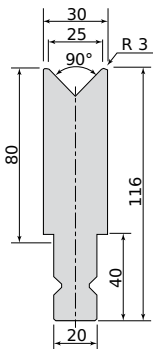

	V25 x 90° / (R 3.00 mm)
Höhe	116.00 mm
Breite	30.00 mm
Belastung	1000 kN/m
Material	
Härte	52 - 56 HRC Unbehandelt
Installation	Stecksystem

	Länge	Bestellnummer		Gewicht
Lang	415 mm	72508E	6H MT72508E	9.40 kg
Kurz	300 mm	72508D	6H MT72508D	-
Segmentiert	235 mm	72508F	6H MT72508F	-
Extra kurz	200 mm	72508C	6H MT72508C	-

Matrizenweite V	4	6	7	8	10	12	14	16	18	20	25	32	40	50	63	80	100	125	160	200	
Kleinste Schenkellänge <i>b_{min}</i>	2.8	4	5	5.5	7	8.5	10	11	13.5	14	17.5	22	28	35	45	55	71	89	113		
Biegeradius <i>ir</i>	0.7	1.0	1.1	1.3	1.6	2.0	2.3	2.6	3.0	3.3	4.0	5.0	6.5	8.0	10	13	16	20	26		
Materialstärke (t) →	0.5 mm	40	30																		
	0.6 mm	60	40	40	40																
	0.8 mm		70	70	50	40															
	1.0 mm		110	100	80	70															
	1.2 mm			140	120	100	80	70	60												
	1.5 mm				170	150	130	110	90	80											
	2.0 mm						220	190	170	150	130	110									
	2.5 mm								280	250	220	180	140								
	3.0 mm									340	300	240	190	150							
	3.5 mm											330	260	200	160	130					
	4.0 mm											430	340	270	210	170					
	4.5 mm												440	340	270	210					
	5.0 mm												520	420	330	260	210				
	6.0 mm												750	600	480	380	300	240			
	7.0 mm															520	410	330	260		
	8.0 mm															850	680	530	430		
9.0 mm																670	540	430			
10 mm																850	670	530	420		
12 mm																	960	780	600	550	
15 mm																			950	750	

Presskrafttabelle für Normalstahl ($R_m \approx 450 \text{ N/mm}^2$)

Matrizenweite V	4	6	7	8	10	12	14	16	18	20	25	32	40	50	63	80	100	125	160	200	250	
Kleinste Schenkellänge b_{min}	2.8	4	5	5.5	7	8.5	10	11	13.5	14	17.5	22	28	35	45	55	71	89	113	140	175	
Biegeradius ir	0.7	1.0	1.1	1.3	1.6	2.0	2.3	2.6	3.0	3.3	4.0	5.0	6.5	8.0	10	13	16	20	26	33	41	
0.5 mm	60	50																				
0.6 mm	90	60	60	60																		
0.7 mm	120	80	80	60	60																	
0.8 mm		110	110	80	70																	
0.9 mm		130	120	100	80	70																
1.0 mm		170	150	120	110	80																
1.2 mm			210	180	150	120	110	90														
1.5 mm						200	170	150	130	120												
2.0 mm						330	290	260	230	200	170											
2.5 mm								390	350	300	250	190										
3.0 mm									510	450	360	290	230									
4.0 mm											650	510	410	320	260							
5.0 mm												780	630	500	390	320						
6.0 mm													900	720	570	450	360					
8.0 mm															1020	810	650	510				
10 mm																1280	1010	800	630			
12 mm																	1440	1170	900	830		
15 mm																		1800	1410	1140		
20 mm																			2500	2080	1670	
25 mm																				3150	2550	
30 mm																						3600

Presskrafttabelle für Edelstahl ($R_m \approx 700 \text{ N/mm}^2$)

AMADA GmbH

Amada Allee 1
42781 Haan

Telefon: +49 2104 2126-0
Fax: +49 2104 2126-999
E-Mail: info@amada.de
www.amada.de